

R F COAXIAL ADAPTERS

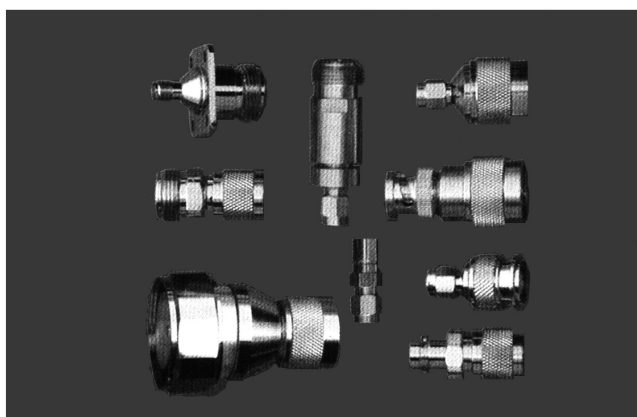

All kinds of coaxial adapters can guarantee the connectors between the same series or different series can be transferred smoothly with each other. All the types of CERNEX coaxial adapters meet the approval of MIL-A-55339 and IEC.

RF COAXIAL ADAPTERS

CERNEX, Inc.

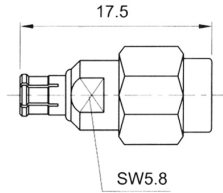

Type	part number	Note
SMA/MCX-JJ	03000-011	

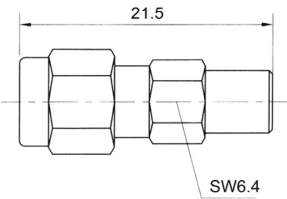

Type	part number	Note
SMA/MCX-JK	03000-021	

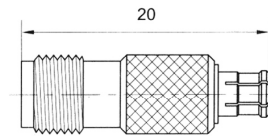

Type	part number	Note
SMA/MCX-KJ	03000-021	

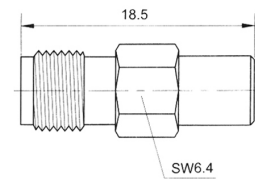

Type	part number	Note
SMA/MCX-KK	03000-001	

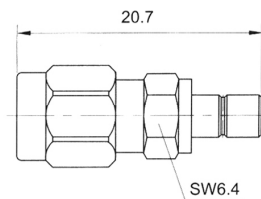
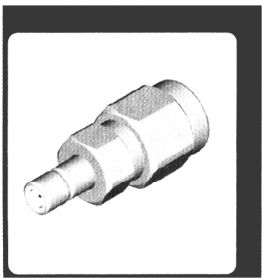

Type	part number	Note
SMA/SMB-JJ	03040-011	

RF COAXIAL ADAPTERS

CERNEX, Inc.

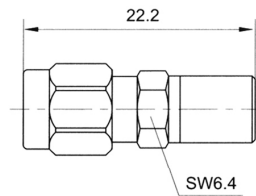

Type	part number	Note
------	-------------	------

SMA/SMB-JK 03040-021

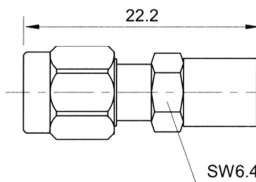

Type	part number	Note
------	-------------	------

SMA/SMB-JKG 03043-021

stainless steel body

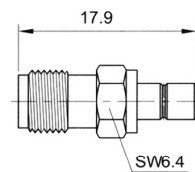

Type	part number	Note
------	-------------	------

SMA/SMB-KJ 03040-022

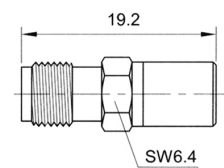

Type	part number	Note
------	-------------	------

SMA/SMB-KK 03040-001

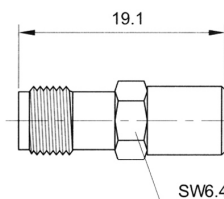

Type	part number	Note
------	-------------	------

SMA/SMB-KKG 03043-001

stainless steel body

RF COAXIAL ADAPTERS

CERNEX, Inc.

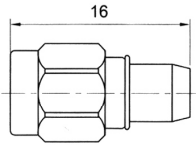

Type	part number	Note
------	-------------	------

BMA/SMA-JJ 01030-011

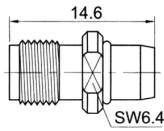

Type	part number	Note
------	-------------	------

BMA/SMA-JK 01030-022

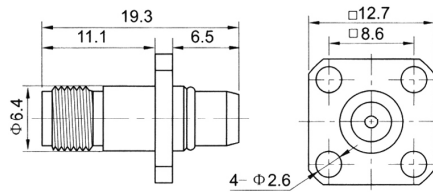

Type	part number	Note
------	-------------	------

BMA/SMA-JFKG 01033-121

stainless steel body

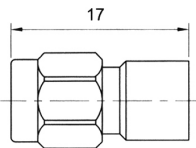
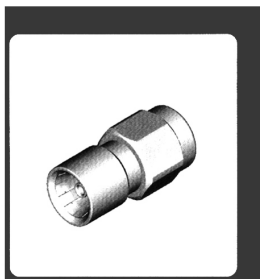

Type	part number	Note
------	-------------	------

BMA/SMA-KJ 01030-021

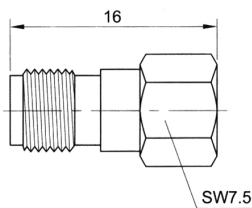

Type	part number	Note
------	-------------	------

BMA/SMA-KK 01030-001

RF COAXIAL ADAPTERS

CERNEX, Inc.

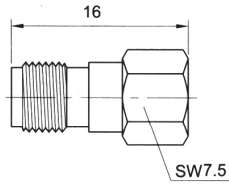

Type	part number	Note
BMA/SMA-KKG	01033-001	stainless steel body

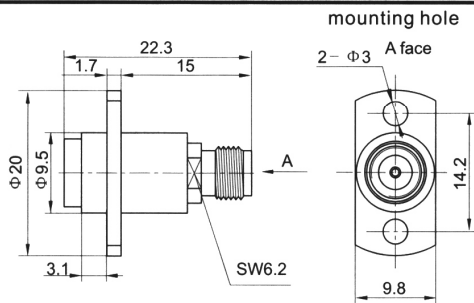

Type	part number	Note
BMA/SMA-KFKG	01033-101	stainless steel body

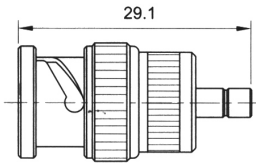

Type	part number	Note
BNC/SMB-JJ	08044-011	

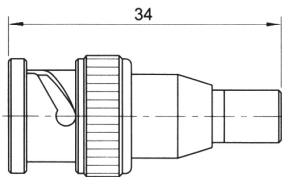
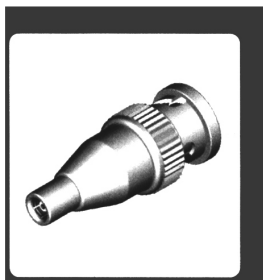

Type	part number	Note
BNC/SMB-JK	08044-021	

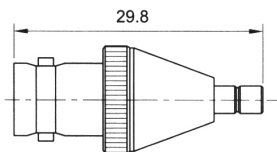

Type	part number	Note
BNC/SMB-KJ	08044-022	

RF COAXIAL ADAPTERS

CERNEX, Inc.

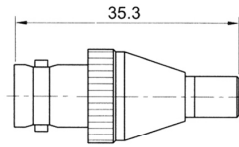
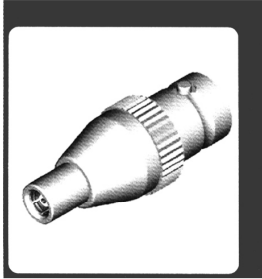

Type	part number	Note
------	-------------	------

BNC/SMB-KK	08044-001	
------------	-----------	--

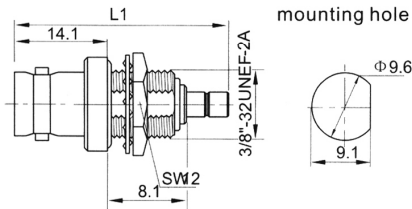

Type	part number	L1	Note
------	-------------	----	------

BNC/SMB-KYJ	08044-221	32.5	
-------------	-----------	------	--

BNC/SMB-KYJ1	08044-222	28.6	
--------------	-----------	------	--

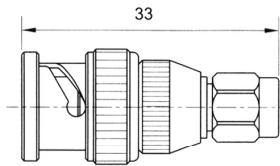

Type	part number	Note
------	-------------	------

BNC/SMA-JJ	08031-011	
------------	-----------	--

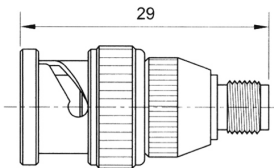

Type	part number	Note
------	-------------	------

BNC/SMA-JK	08031-021	
------------	-----------	--

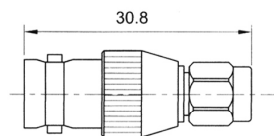

Type	part number	Note
------	-------------	------

BNC/SMA-KJ	08031-022	
------------	-----------	--

RF COAXIAL ADAPTERS

CERNEX, Inc.

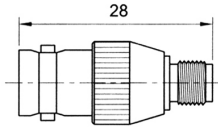

Type	part number	Note
------	-------------	------

BNC/SMA-KK 08031-001

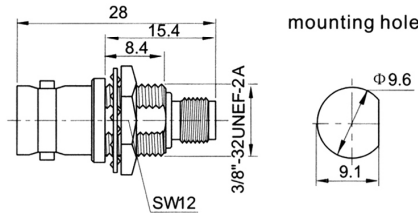

Type	part number	Note
------	-------------	------

BNC/SMA-KYK 08034-201

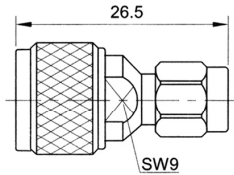

Type	part number	Note
------	-------------	------

TNC/SMA-JJ 07031-011

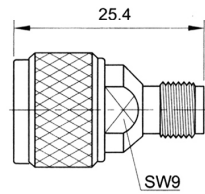

Type	part number	Note
------	-------------	------

TNC/SMA-JK 07031-021

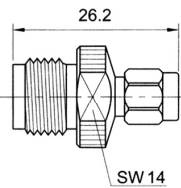

Type	part number	Note
------	-------------	------

TNC/SMA-KJ 07031-022

RF COAXIAL ADAPTERS

CERNEX, Inc.

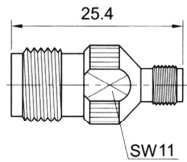

Type	part number	Note
------	-------------	------

TNC/SMA-KK 07031-001

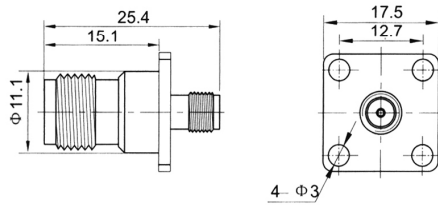
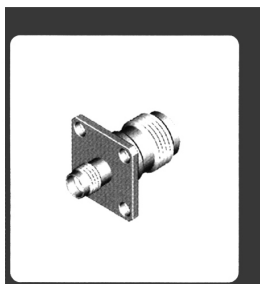

Type	part number	Note
------	-------------	------

TNC/SMA-KFK 07031-101

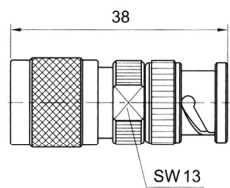

Type	part number	Note
------	-------------	------

TNC/BNC-JJ 07081-011

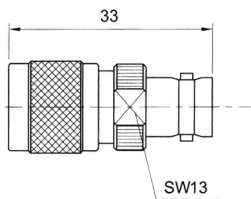

Type	part number	Note
------	-------------	------

TNC/BNC-JK 07081-021

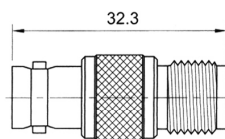

Type	part number	Note
------	-------------	------

TNC/BNC-KK 07081-001

RF COAXIAL ADAPTERS

CERNEX, Inc.

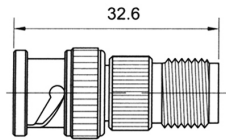

Type	part number	Note
------	-------------	------

TNC/BNC-KJ	07031-131	
------------	-----------	--

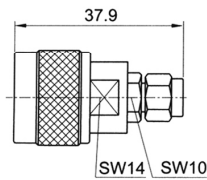

Type	part number	Note
------	-------------	------

N/3.5mm-JJ	06254-011	
------------	-----------	--

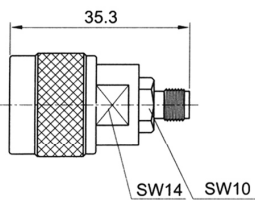

Type	part number	Note
------	-------------	------

N/3.5mm-JK	06254-021	
------------	-----------	--

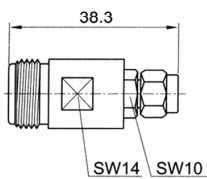

Type	part number	Note
------	-------------	------

N/3.5mm-KJ	06254-022	
------------	-----------	--

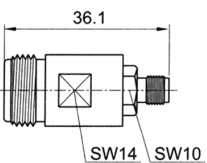

Type	part number	Note
------	-------------	------

N/3.5mm-KK	06254-001	
------------	-----------	--

RF COAXIAL ADAPTERS

CERNEX, Inc.

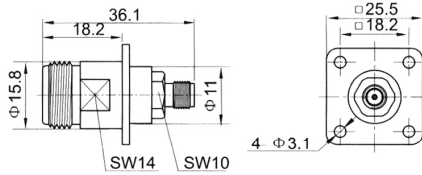
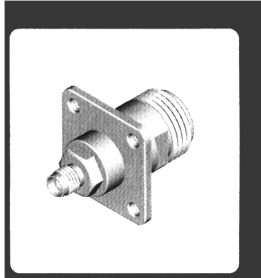

Type	part number	Note
------	-------------	------

N/3.5mm-KFK	06254-101	
-------------	-----------	--

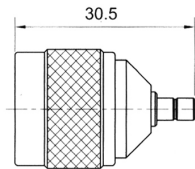

Type	part number	Note
------	-------------	------

N/SMB-JJ	06044-011	
----------	-----------	--

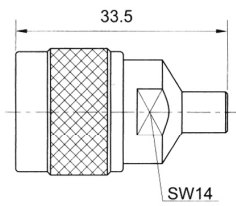

Type	part number	Note
------	-------------	------

N/SMB-JK	06044-022	
----------	-----------	--

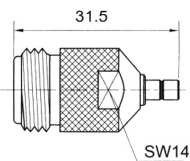
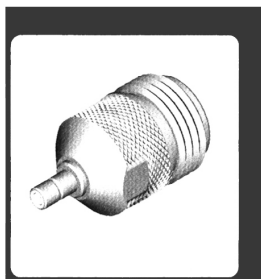

Type	part number	Note
------	-------------	------

N/SMB-KJ	06044-021	
----------	-----------	--

N/SMB-KJ1	06044-022	SUCO plated
-----------	-----------	-------------

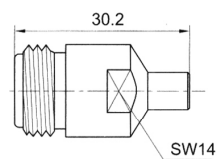
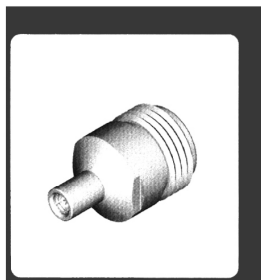

Type	part number	Note
------	-------------	------

N/SMB-KK	06044-001	
----------	-----------	--

RF COAXIAL ADAPTERS

CERNEX, Inc.

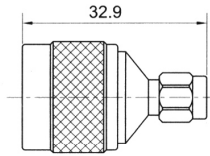

Type	part number	Note
------	-------------	------

N/SMA-JJ	06031-011	
----------	-----------	--

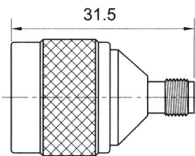

Type	part number	Note
------	-------------	------

N/SMA-JK	06031-021	
----------	-----------	--

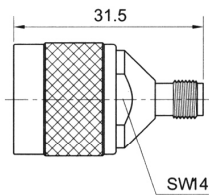

Type	part number	Note
------	-------------	------

N/SMA-JKG	06033-021	
-----------	-----------	--

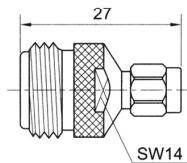

Type	part number	Note
------	-------------	------

N/SMA-KJ	06031-022	
----------	-----------	--

N/SMA-KJG	06033-022	stainless steel body
-----------	-----------	----------------------

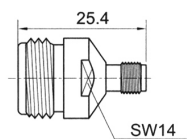

Type	part number	Note
------	-------------	------

N/SMA-KK	06031-001	
----------	-----------	--

RF COAXIAL ADAPTERS

CERNEX, Inc.

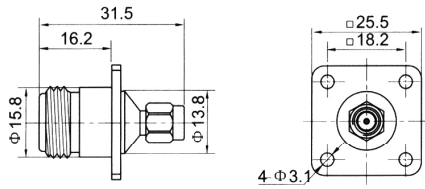
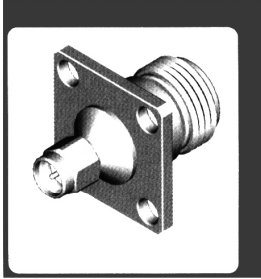

Type part number Note

N/SMA-KFJ 06031-121

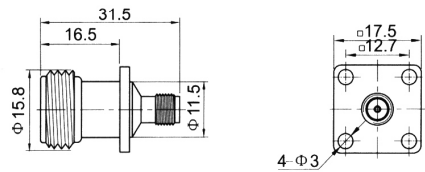
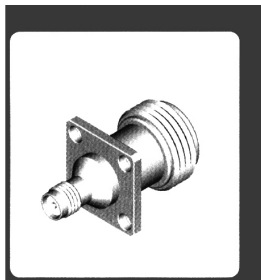

Type part number Note

N/SMA-KFK1 06031-102

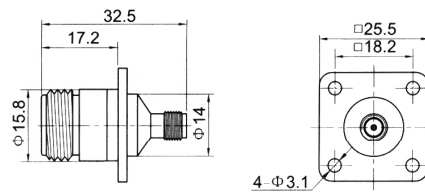

Type part number Note

N/SMA-KFK2 06031-103

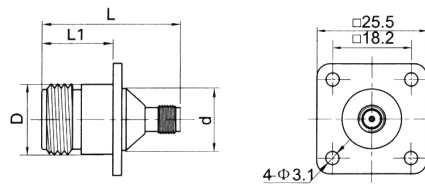
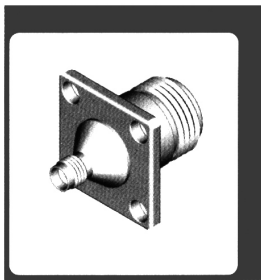

Type part number L L1 D d Note

N/SMA-KFK3	06031-104	31.5	16.2	15.8	13.8
N/SMA-KFK4	06031-105	37.5	22.2	15.8	14

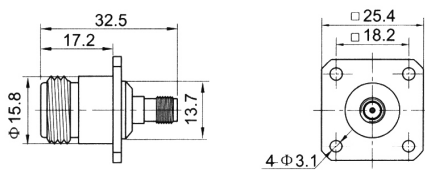
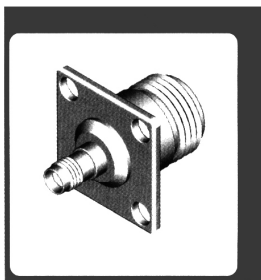

Type part number Note

N/SMA-KFK6G 06033-101

RF COAXIAL ADAPTERS

CERNEX, Inc.

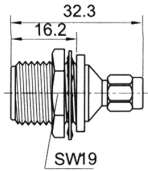

Type	part number	Note
------	-------------	------

N/SMA-KYJ	06031-221	
-----------	-----------	--

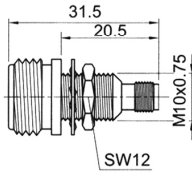

Type	part number	Note
------	-------------	------

N/SMA-KYK	06031-201	
-----------	-----------	--

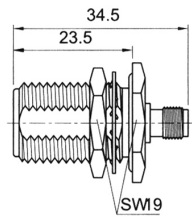

mounting hole

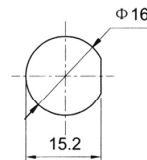

Type	part number	Note
------	-------------	------

N/SMA-KYKG	06033-201	
------------	-----------	--

stainless steel body

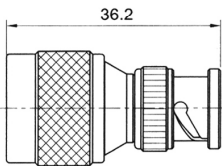

Type	part number	Note
------	-------------	------

N/BNC-JJ	06081-001	
----------	-----------	--

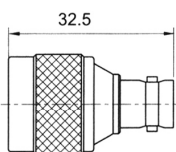

Type	part number	Note
------	-------------	------

N/BNC-JK	06081-021	
----------	-----------	--

RF COAXIAL ADAPTERS

CERNEX, Inc.

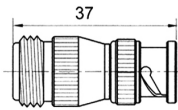

Type	part number	Note
N/BNC-KJ	06081-021	

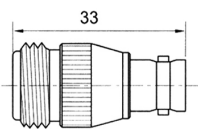

Type	part number	Note
N/BNC-KK	06081-001	

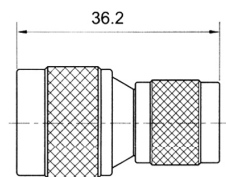

Type	part number	Note
N/TNC-JJ	06071-011	

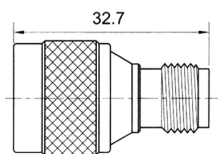

Type	part number	Note
N/TNC-JK	06071-022	

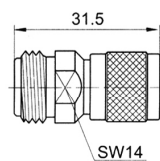

Type	part number	Note
N/TNC-KJ	06071-021	

RF COAXIAL ADAPTERS

CERNEX, Inc.

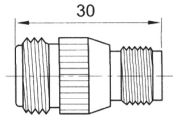

Type	part number	Note
------	-------------	------

NTNC-KK	06071-001	
---------	-----------	--

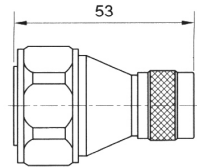

Type	part number	Note
------	-------------	------

L29/N-JJ	12061-011	
----------	-----------	--

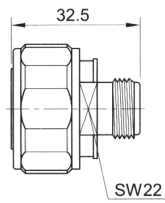

Type	part number	Note
------	-------------	------

L29/N-JK	12061-021	
----------	-----------	--

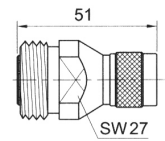

Type	part number	Note
------	-------------	------

L29/N-KJ	12061-022	
----------	-----------	--

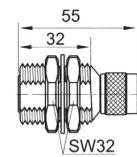

mounting hole

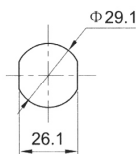

Type	part number	Note
------	-------------	------

L29/N-KJ2	12061-024	
-----------	-----------	--

RF COAXIAL ADAPTERS

CERNEX, Inc.

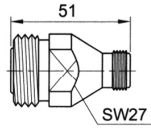

Type	part number	Note
L29/N-KK	12061-001	